

We touch your **electricity** everyday!

robust**a**

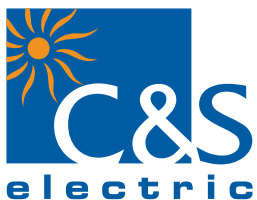

UL CE SF RoHS
Compliant



Contactors Panorama

robusta Contactor

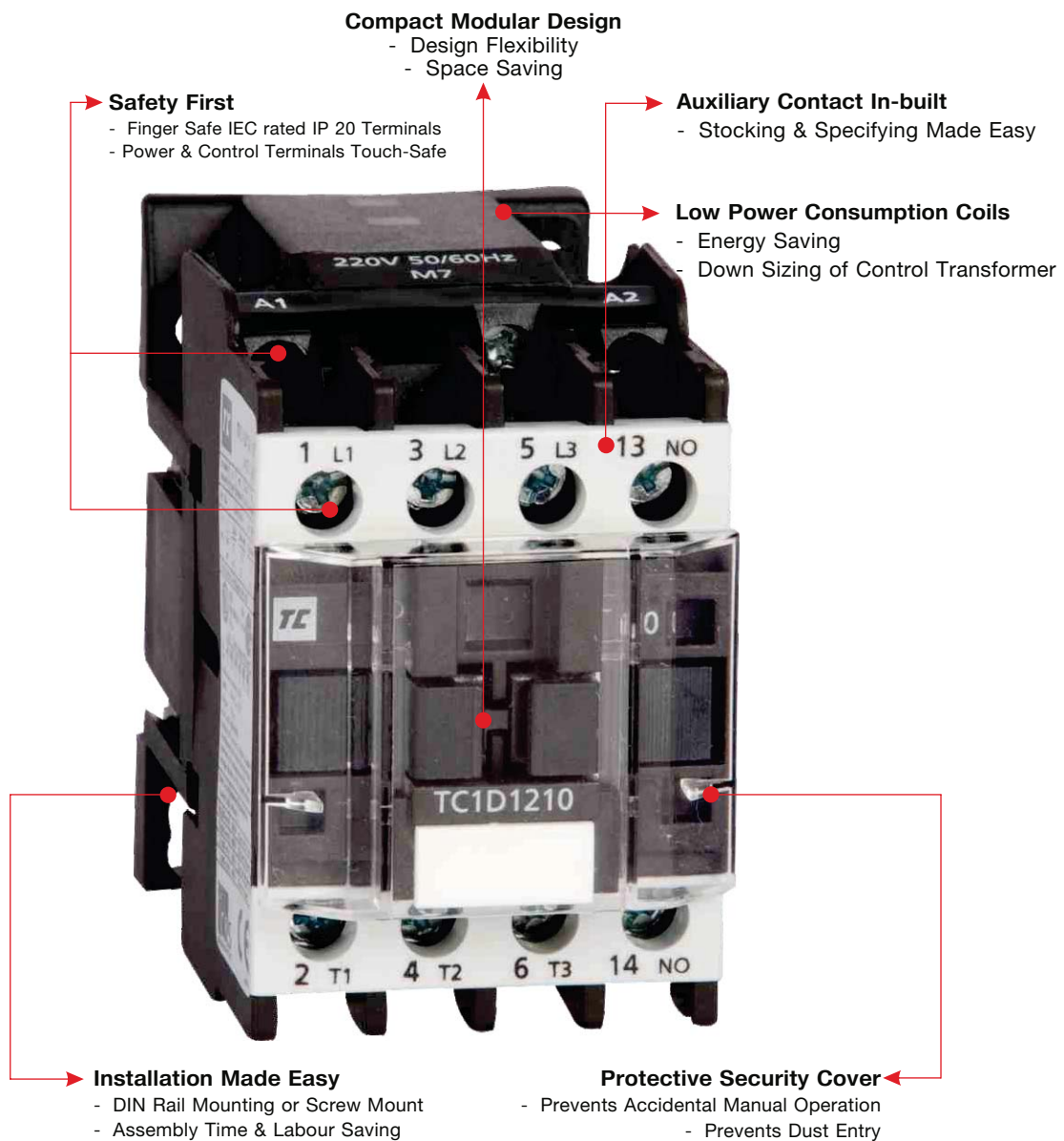

It's all about ...

Life & Performance

Introduction

TC robusTa Contactor is manifestation of understanding discerning customer's requirements and applications. As the name suggests, robusTa Contactor are built for high performance assuring designs flexibility, safety and cost effective solutions.

robusTa Contactor are manufactured in our State-of-the-Art fully integrated ISO 90001 Certified manufacturing facility possessing comprehensive infrastructure inclusive of design, tooling, component manufacturing, assembling and testing to ensure World Class Products.

robusTa Contactors are user friendly, highly reliable & its modular design affords product selection with cost effective solutions.

robusTa Contactor & Overload Relay meets latest IEC, UL, CSA & CE Standards possessing Global accreditation. They conform to IEC60947-4-1.

robusTa Contactor starting solutions advantages

- World Class Superior functional aesthetics
- Complete & harmonized 3& 4P Contactor range
 - 3P Contactor AC3 rating 9~95A, 4 frame sizes, AC/ DC
 - 3P Contactor AC3 rating 115~800A, 8 frame sizes, AC/ DC
 - 4P Contactor AC1 rating 25~ 125A, 4 frame sizes, AC/ DC
 - 4P Contactor AC1 rating 200~1600A, 8 frame sizes, AC/ DC
- Safety first - Power & Control terminals are finger touch proof.
- Energy Saving magnet coils in both AC & DC variants
- Compact Modular design for flexibility
- Saves inventory cost - Common Add -On Accessories
- High Mechanical & Electrical life
- Short Circuit Protection, Type -1 & 2 Co-ordination

Industrial Applications

- Motor Controls
- Pumps
- Machine Tools
- Printing & Packaging Machines
- Compressors
- Power Supply Solutions
- HVAC
- Cranes
- Elevator & Escalators
- Wind Mills
- Solar System



robusta Contactor Series - 3 Pole

Conforming: IS 13947-4-1 / IEC 60947-4-1



Technical Parameters - Contactor: 9A ~ 95A

Types	3 Pole	AC DC	TC1-D09	TC1-D12	TC1-D18	TC1-D22
			TP1-D09	TP1-D12	TP1-D18	TP1-D22
Maximum Rated Current for AC3 Duty			9A	12A	18A	22A
Rated Operational Voltage: Ue			690			
Thermal Current: Ith			25A		32A	
Power Rating for Motor Control for AC3 Duty $\theta \leq 55^{\circ}\text{C}$, Conforming to UL, CSA	415V 230V 460/480V 575/600V		kW / HP	kW / HP	kW / HP	kW / HP
			4 / 5.5	5.5 / 7.5	9 / 12.5	11 / 15
			2	3	5	-
			5	7.5	10	-
			7.5	10	15	-
Mounting Position			± 30			
Ambient Air Temperature (Operational)			- 5 to + 55°C			
Maximum Operating Rate Operations / Hrs.		AC / DC	3600			
Mechanical Life		50 Or 60 Hz	20			
Thermal / Electronic Overload Relay			0.10~13.0			
Auxillary Contact Block	Front Mounted: Side Mounted:		1 NO, 1NC, 2NO, 1 NO+1NC, 2NC, 4NO, 3NO+1NC, 2NO+2NC, 1NO+3NC, 4NC			
			1NO+1NC, 2NC			
Pneumatic Timer	Front Mounted:		On Delay 1NO+1NC (0.1~180 Sec) OFF Delay 1NO+1NC (0.1~180 Sec)			
	Star Delta Timer:		1 NO+1NC (0.1~30 Sec)			
Mechanical Interlock	Horizontally Mounted:		AC: TC1D09 - TC1D95 DC: TP1D09 - TP1D80			
Surge Suppressor			Varistor AC/DC: 24~48V, 110~240V RC Circuit AC: 24~48V, 110~240V, 380~440V			

AC Coil Voltage for
3 Pole Contactors 9A~95A & Control Relays

Contactor	Voltage					
TCA2-DN/TC1-D	24	48	110*	220*	240*	415
50Hz	B5	E5	F5	M5	U5	N5
50/60Hz	B7	E7	F7	M7	U7	N7

Over-all dimensions in (mm)		AC			
		50/60	50/60	50/60	50/60

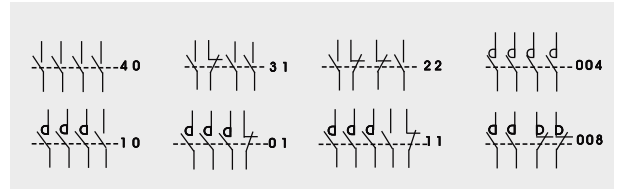

TC1-D25	TC1-D32	TC1-D38	TC1-D40	TC1-D50	TC1-D65	TC1-D80	TC1-D95
TP1-D25	TP1-D32	TP1-D38	TP1-D40	TP1-D50	TP1-D65	TP1-D80	TP1-D95
25A	32A	38A	40A	50A	65A	80A	95A
690							
40A	50A		60A	80A		125A	
kW / HP 11 / 15	kW / HP 15 / 20	kW / HP 18.5 / 25	kW / HP 22 / 30	kW / HP 25 / 35	kW / HP 37 / 50	kW / HP 45 / 60	kW / HP 45 / 60
7.5	10	-	10	15	20	25	25
15	20	-	30	40	50	60	60
20	25	-	30	40	50	60	60
± 30							
- 5 to + 55'							
3600							
16						10	
13.0~37.0				40.0~63.0		63.0~93.0	

DC Coil Voltage for
3 Pole Contactors 9A-95A & Control Relays

Contactor	Voltage				
TCA3-DN/ TP1-D	24	48	72	110	220
Normal Coil	BD	ED	SD	FD	MD
Wide band Coil#	BW	EW	-	FW	-

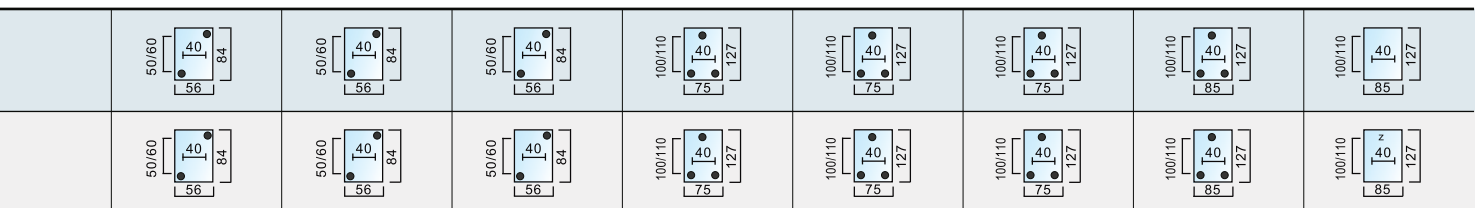

robusta Contactor Series - 3 Pole

Conforming: IS 13947-4-1 / IEC 60947-4-1



Technical Parameters - Contactor: 115A ~ 780A

Types	3 Pole	AC DC	LC1-F115	LC1-F150	LC1-F185	LC1-F225	
			LC1-F1154	LC1-F1504	LC1-F1854	LC1-F2254	
Maximum Rated Current for AC3 Duty			115A	150A	185A	225A	
Thermal Current: I _{th}			200A	250A	275A	315A	
Rated Operational Voltage : U _e			1000A				
Power Rating for Motor Control for AC3 Duty Conforming to UL, CSA	∅ ≤ 55°C, 415V	230V	kW / HP	kW / HP	kW / HP	kW / HP	
			59 / 80	80 / 108	100 / 136	110 / 148	
			460/480V	40	50	60	65
			575/600V	75	100	125	130
			100	125	150	155	
Mounting Position			± 30				
Ambient Air Temperature Operation			-5 to + 55°C				
Maximum Operating Rate (Operations/hrs)		AC/DC	2400				
Mechanical Life		50 OR 60 Hz	10				
Thermal/electronic Overload Relay			65.0~200.0				
Auxillary Contact Block	Front Mounted:		1NO, 1NC, 2NO, 1 NO+1NC, 2NC, 4NO, 3NO+1NC, 2NO+2NC, 1NO+3NC, 4NC				
	Side Mounted:		1NO+1NC, 2NO				
Pneumatic Timer	Front Mounted:		On Delay 1NO+1NC (0.1~180 Sec) OFF Delay 1NO+1NC (0.1~180 Sec)				
	Star Delta Timer:		1NO+1NC (0.1~30 Sec)				
Mechanical Interlock	Horizontally Mounted:		AC/DC: LC1-F115A~LC1-F630A				
	Vertically Mounted:		AC/DC: LC1-F115A-LC1-F780A				
Surge Suppressor			Varistor AC/DC: 24~48V, 110~240V, RC Circuit (AC): 24~48V, 110~240V, 380~440V				

AC Coil Voltage for 3 Pole Contactors 115A~780A

Contactor	Voltage			
Type	110	220	240t	415
LC1FDP	F	M	U	N

Over-all dimensions in mm

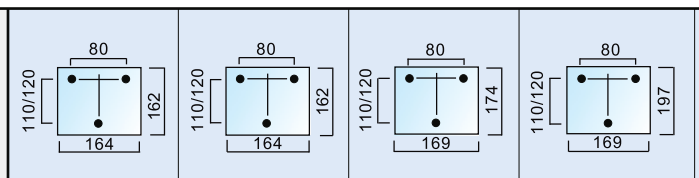

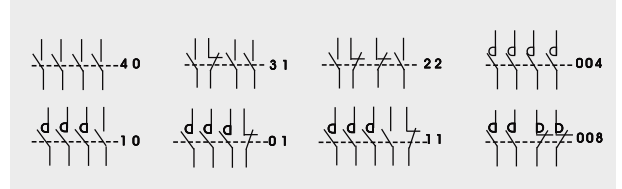

LC1-F265	LC1-F330	LC1-F400	LC1-F500	LC1-F630	LC1-F780
LC1-F2654	LC1-F3304	LC1-F4004	LC1-F5004	LC1-F6304	LC1-F7804
265A	330A	400A	500A	630A	780A
350A	400A	500A	700A	1000A	1600A
1000A					
kW / HP 140 / 190	kW / HP 180 / 240	kW / HP 220 / 300	kW / HP 280 / 380	kW / HP 375 / 500	kW / HP 425 / 580
75	100 125	200	300	-	
150	200	250	400	600	-
200	250	300	500	800	-
± 30					
-5 to + 55°C					
2400				1200	600
10					5
200.0~630.0				630.0~1000.0	

DC Coil Voltage for 3 Pole Contactors 115A~780A

Contactor	Voltage			
Type	24#	48	110	220
LC1FDP	BD	ED	FD	MD

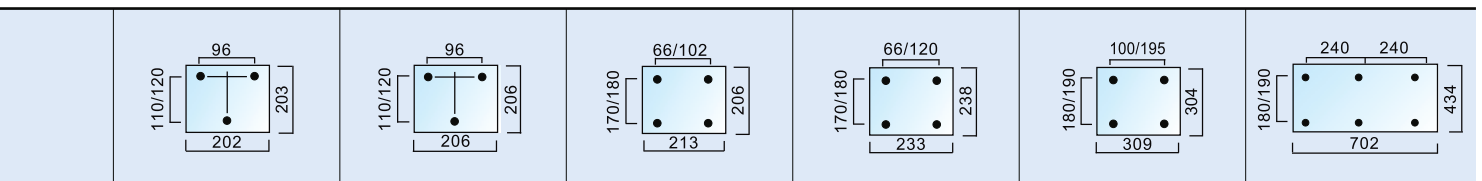

robusta Contactor Series - 4 Pole

Conforming: IS 13947-4-1 / IEC 60947-4-1



Technical Parameters - Control Relay/Contactor: 9A ~ 80A

Types	4 Pole	AC DC	TCA2-DN	TC1-D09004	TC1-D12004
			TCA3-DN	TP1-D09004	TP1-D12004
Rated Thermal Current: I_{th} , AC-1, 40 °C			10A	25A	25A
Main Pole Configuration			4NO		4NO
Rated Operational Voltage: U_e			660		690
Mounting Position			± 30		± 30
Ambient Air Temperature Operation			-5 to + 55°C		-5 to + 55°C
Maximum Operating Rate (operations/hr)	AC/DC		10800/3600		3600
Mechanical Life	50 or 60 Hz		30		20
Auxillary Contact Block	Front Mounted:		1NO, 1NC, 2NO, 1NO+1NC, 2NC, 4NO, 3NO+1NC, 2NO+2NC, 1NO+3NC, 4NC		
	Side Mounted:		1NO+1NC, 2NO		
Pneumatic Timer	Front Mounted:		On Delay 1NO+1NC (0.1~180 Sec) OFF Delay 1NO+1NC (0.1~180 Sec)		
	Star Delta Timer:		1NO+1NC (0.1~30 Sec)		
Mechanical Interlock	Horizontally Mounted:		AC: TC1-D09~TC1D95 DC: TP1~D09 - TP1-D80		
Surge Suppressor			Varistor AC/DC: 24~48V, 110~240V RC Circuit AC: 24~48V, 110~240V, 380~440V		

robusta Common Add - On Accessories

Auxiliary Contact Block (Side mounted)

TA8-DN

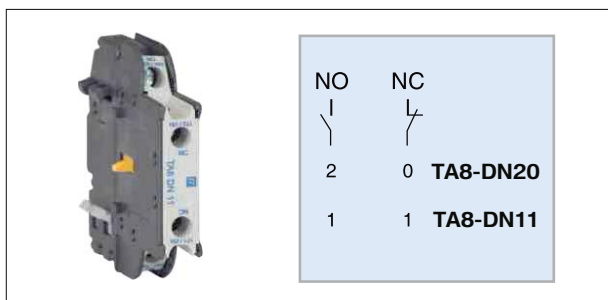

Auxiliary Contact Block (Front mounted)

TA1-DN

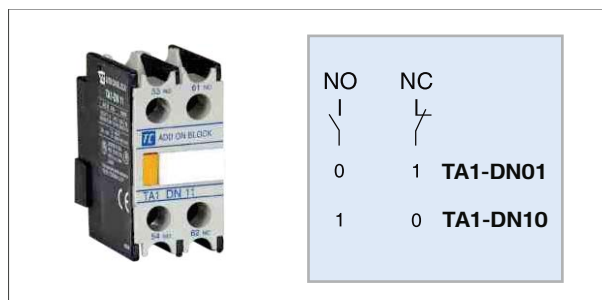

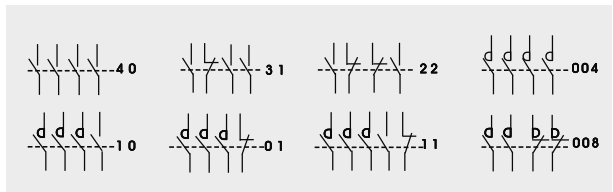

TC1-D25004	TC1-D40004	TC1-D65004	TC1-D80004
TP1-D25004	TP1-D40004	TP1-D65004	TP1-D80004
40A	60A	80A	125A
4NO			4NO
690			690
± 30			± 30
-5 to + 55°C			-5 to + 55°C
3600			3600
16			16

robusta Common Add - On Accessories

Auxiliary Contact Block (Front mounted)
TA1-DN



NO	NC	
1	1	TA1-DN11
0	2	TA1-DN02
2	0	TA1-DN20

Latch Add-on Block (Front mounted)
LA6-DK01



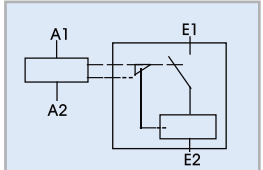

LA6-DK01

robusta Contactor Series - 4 Pole

Conforming: IS 13947-4-1 / IEC 60947-4-1



Technical Parameters - Contactor: 115 ~ 780A

Types	4 Pole	AC DC	LC1-F115	LC1-F150	LC1-F185	LC1-F225
			LC1-F1154	LC1-F1504	LC1-F1854	LC1-F2254
Rated Thermal Current: I_{th} , AC-1, 40 °C			200A	250A	275A	315A
Main Pole Configuration			4 NO			
Rated Operational Voltage: U_e			1000			
Mounting Position			± 30			
Ambient air temperature operation			- 5 to + 55°C			
Maximum operating rate (operations/hrs)		AC/DC	2400			
Mechanical Life		50 OR 60 Hz				
Auxillary Contact Block	Front Mounted:		1NO, 1NC, 2NO, 1NO+1NC, 2NC, 4NO, 3NO+1NC, 2NO+2NC, 1NO+3NC, 4NC			
		Side Mounted:	1NO+1NC, 2NO			
Pneumatic Timer	Front Mounted:		ON Delay 1NO+1NC (0.1~180 Sec) OFF Delay 1NO+1NC (0.1~180 Sec)			
	Star Delta Timer:		1NO+1NC (1~30 Sec)			
Mechanical Interlock	Horizontally Mounted:		AC/DC: LC1-F115A-LC1-F630A			
	Vertically Mounted:		AC/DC: LC1-F115A-LC1-F780A			
Surge Suppressor			Varistor AC/DC: 24~48V, 110~240V RC Circuit (AC): 24~48V, 110~240V, 380V~440V			

Common Add - On Accessories

On Delay Timer Block (Front mounted)
TA2-DT2

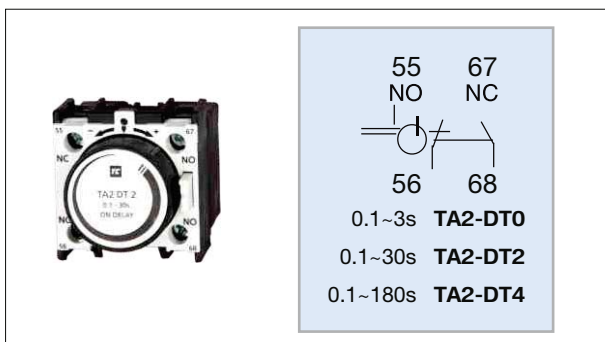

Off Delay Timer Block (Front mounted)
TA3-DR2

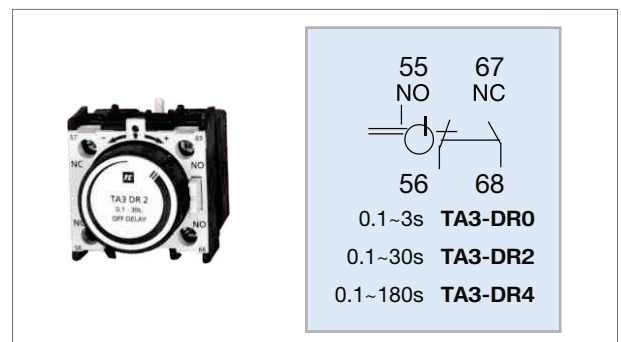

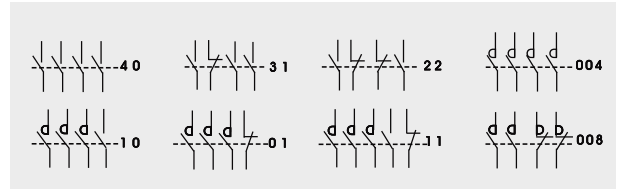

LC1-F265	LC1-F330	LC1-F400	LC1-F500	LC1-F630	LC1-F780
LC1-F2654	LC1-F3304	LC1-F4004	LC1-F5004	LC1-F6304	LC1-F7804
350A	400A	500A	700A	1000A	1600A
4 NO		4 NO		4 NO	
1000		1000		1000	
± 30		± 30		± 30	
- 5 to + 55°C		- 5 to + 55°C		- 5 to + 55°C	
2400		2400		1200	600

Common Add - On Accessories

On Delay Star Delta Timer Block (Front Mounted)
TA2-DS2

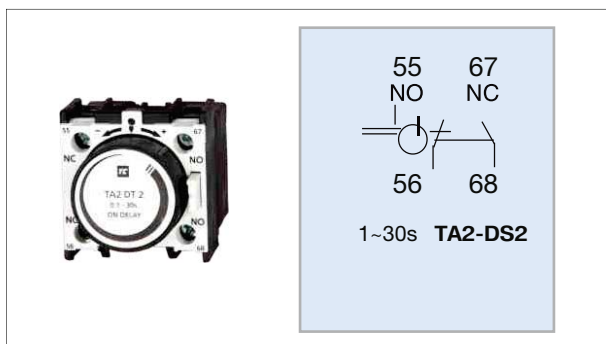

Auxiliary Contact Block (Front mounted)
TA1-DN2

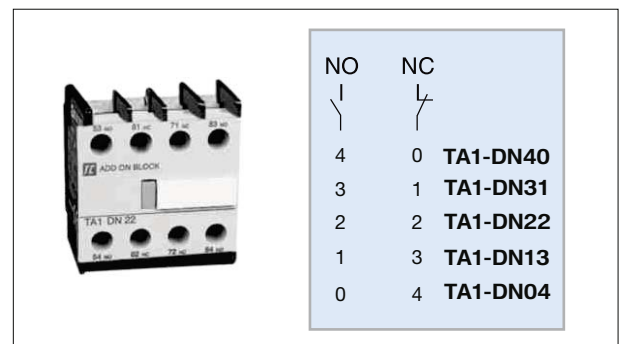

robusta Contactor Series - Electrical Life Curve

Use in Category AC-1 ($U_e \leq 440V$).

Control of resistive circuits ($\cos\phi > 0.95$). The current broken (I_c) in category AC-1 is equal to the current (I_n) normally drawn by the load.

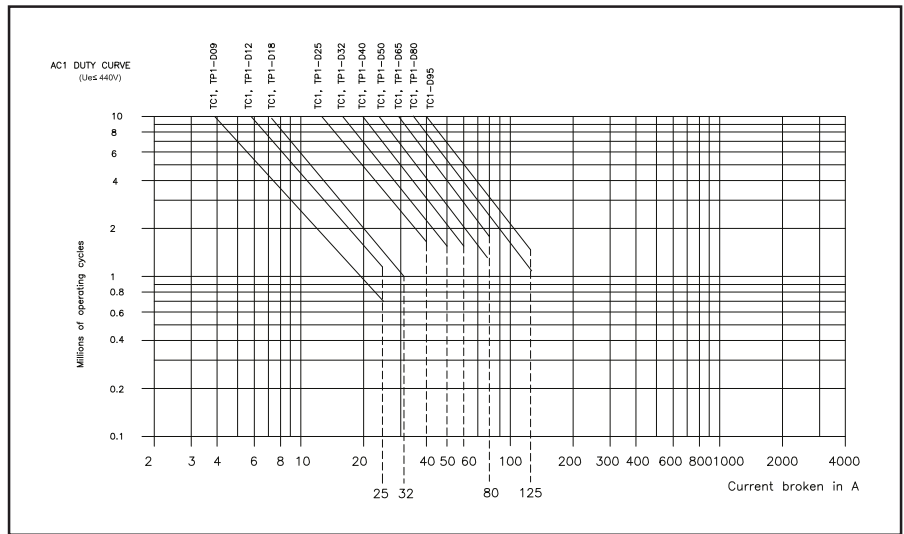

Use in Category AC-3 ($U_e \leq 440V$).

Control of 3-phase asynchronous squirrel cage motors with breaking whilst motor running. The current broken (I_c) in category AC-3 is equal to the current (I_n) normally drawn by the load.

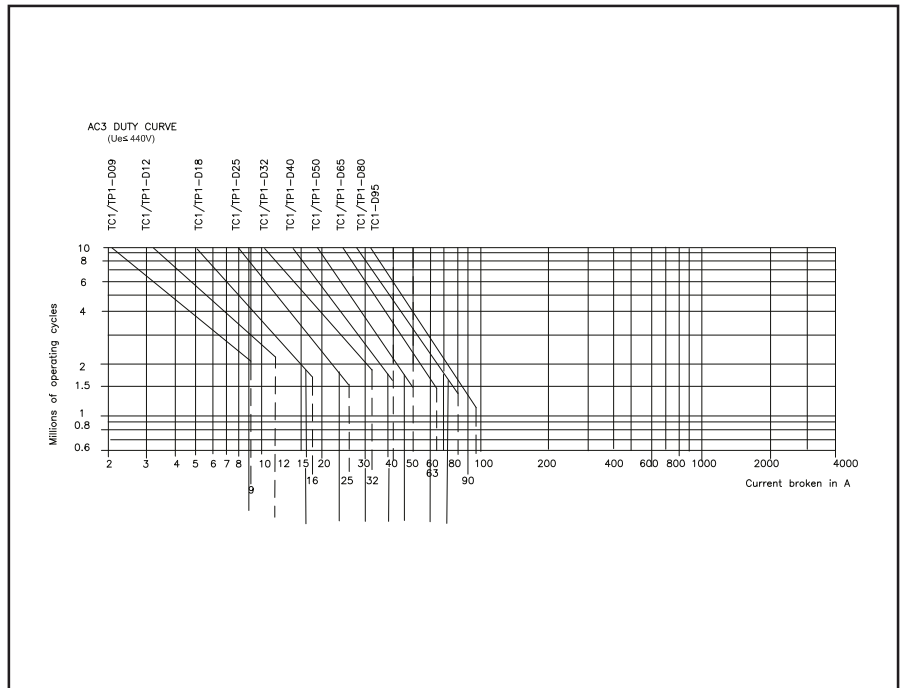

Use in Categories AC-2, AC-4 ($U_e \leq 440V$).

Control of 3-phase asynchronous squirrel cage (AC-4) or slip ring (AC-2) motors with breaking whilst motor stalled. The current broken in category AC-4 is equal to $6 \times I_n$. (I_n = rated operational current of the motor).

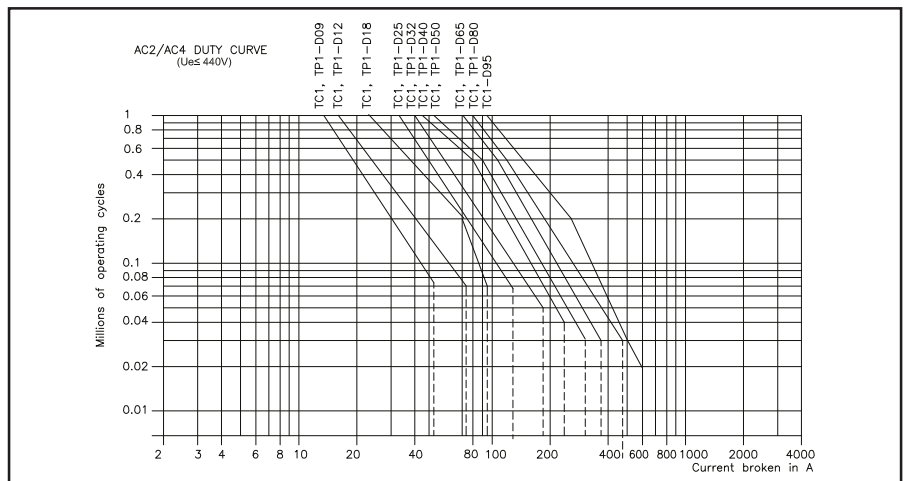

Use in Category AC-1 ($U_e \leq 440V$).

Control of resistive circuits ($\cos\phi \geq 0.95$). The current broken (I_b) in category AC-1 is equal to the current (I_n) normally drawn by the load.

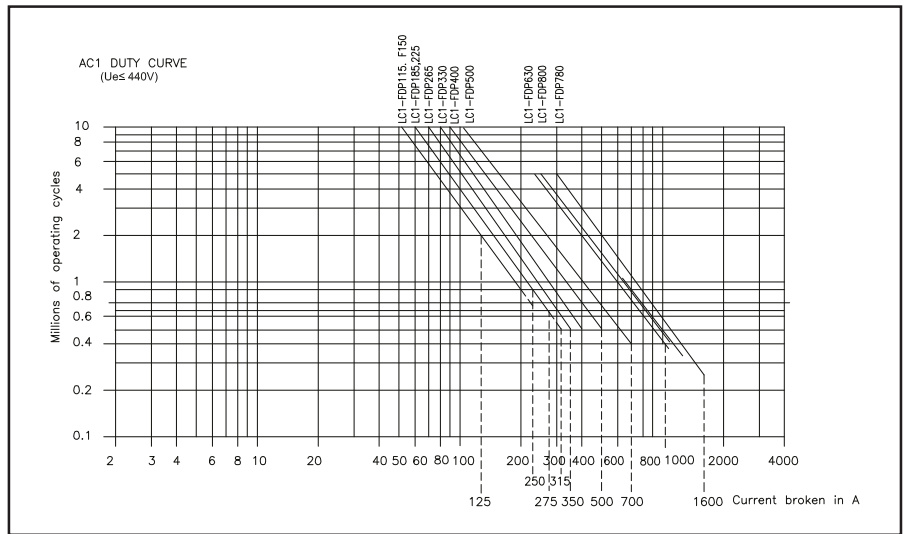

Use in Category AC-3 ($U_e \leq 440V$).

Control of 3-phase asynchronous squirrel cage motors with breaking whilst motor running. The current broken (I_b) in category AC-3 is equal to the current (I_n) normally drawn by the load.

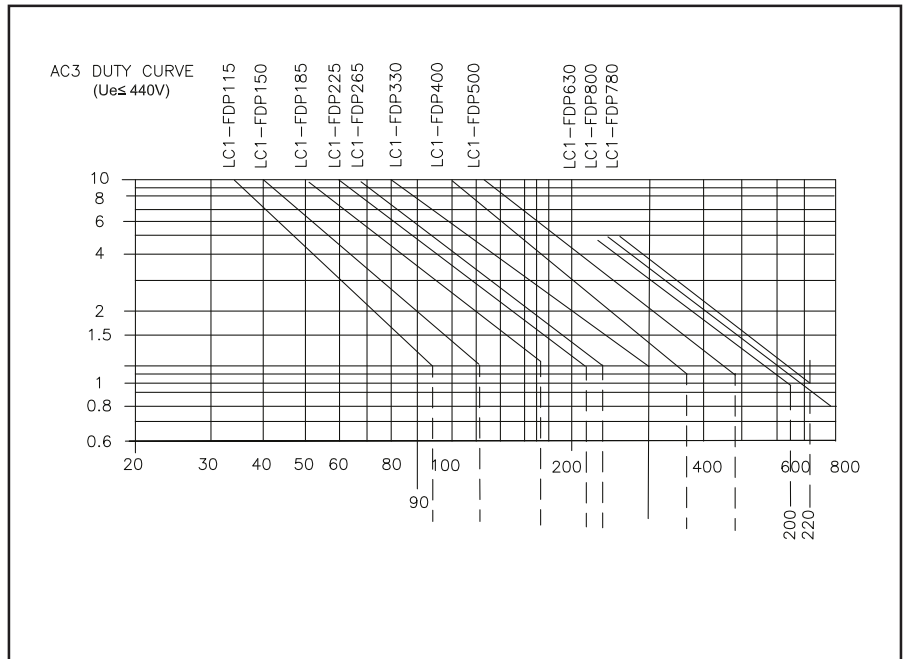

Use in Categories AC-2, AC-4 ($U_e \leq 440V$).

Control of 3-phase asynchronous squirrel cage (AC-4) or slip ring (AC-2) motors with breaking whilst motor stalled. The current broken in category AC-4 is equal to $6 \times I_n$. (I_n = rated operational current of the motor).

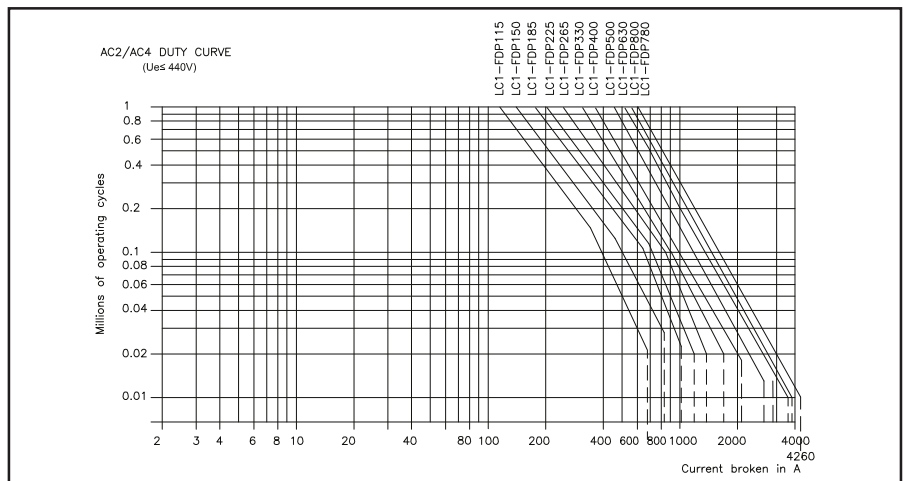

* Product Innovation is a continuous process, hence data given is subject to change without notice

robusta Overload Relays - Specifications

robusta Thermal Overload Relay provides protection against operational overload & single phasing having prior of site selectable auto or manual facility

Silent Features

- Built-in single phase protection.
- Potential free 1NO and 1NC contacts.
- Yellow flag indicator for indication of relay tripping.
- Manual reset facility.
- IP 20 finger touch proof

Relay Reference	Relay setting range (A)	Standard power ratings of 3-Phase Motors 50/60Hz, AC3 Category					Back Up		Base Plate* reference
		220V	380V	415V	440V	660V	Fuse Rating		
		KW	KW	KW	KW	KW	aM (A)	g1 (A)	
TR2-D09301	0.1 to 0.16	-	-	-	-	-	0.25	2	TA7D0964
TR2-D09302	0.16 to 0.25	-	-	-	-	-	0.5	2	
TR2-D09303	0.25 to 0.4	-	-	-	-	-	1	2	
TR2-D09304	0.4 to 0.63	-	-	-	-	0.37	1	2	
TR2-D09305	0.63 to 1	-	-	-	-	0.55	2	4	
TR2-D09306	1 to 1.6	-	0.37	-	0.55	1.1	2	4	
TR2-D093X6	1.25 to 2	-	0.55	0.75	0.75	1.3	4	6	
TR2-D09307	1.6 to 2.5	0.37	0.75	1.1	1.1	1.5	4	6	
TR2-D09308	2.5 to 4	0.75	1.5	1.5	1.5	3	6	10	
TR2-D09310	4 to 6	1.1	2.2	2.2	2.2	4	8	16	
TR2-D09312	5.5 to 8	1.5	3	3.7	3.7	5.5	12	20	
TR2-D09314	7 to 10	2.2	4	4	4	7.5	12	20	
TR2-D12316	9 to 13	3	5.5	5.5	5.5	10	16	25	
TR2-D18321	12 to 18	4	7.5	9	9	15	20	35	
TR2-D25322	17 to 25	5.5	11	11	11	18.5	25	50	TA7D3264
TR2-D32353	23 to 32	7.5	15	15	15	-	40	63	
TR2-D32355	28 to 36	9	15	18.5	18.5	-	40	80	
TR2-D40355	30 to 40	10	18.5	22	22	30	40	100	TA7D4064
TR2-D65357	37 to 50	11	22	25	25	37	63	100	
TR2-D65359	48 to 65	18.5	25	30	30	50	63	100	
TR2-D65361	55 to 70	20	30	37	37	55	80	125	
TR2-D80363	63 to 80	22	33	40	40	59	80	125	
TR2-D95365	80 to 93	25	45	49	50	80	100	160	
LR1-F105	65 to 105	25	51	55	59	90	0.25	160	-
LR1-F125	80 to 125	30	59	59	63	110	125	200	
LR1-F160	100 to 160	45	80	80	90	140	160	250	
LR1-F200	125 to 200	55	90	100	110	160	200	315	
LR1-F250	160 to 250	63	110	129	140	200	250	400	
LR1-F315	200 to 315	80	150	160	160	257	315	500	
LR1-F400	250 to 400	110	185	200	220	335	400	630	
LR1-F500	315 to 500	140	250	257	280	445	500	800	
LR1-F630	400 to 630	180	315	355	375	500	630	800	
*LR1-F800	500 to 800	220	400	425	450	—	-	1000	
*LR1-F1000	630 to 1000	295	500	500	500	—	-	1250	

Notes : 1. Protected shrouds for main poles or power poles to be ordered separately for LR1 Relays
 2. Standard Fault Ratings with TR2 Relay.
 *UL/CSA not available

Overload Relay Tripping Curves, Dimensions

Overload Relay Tripping Curves

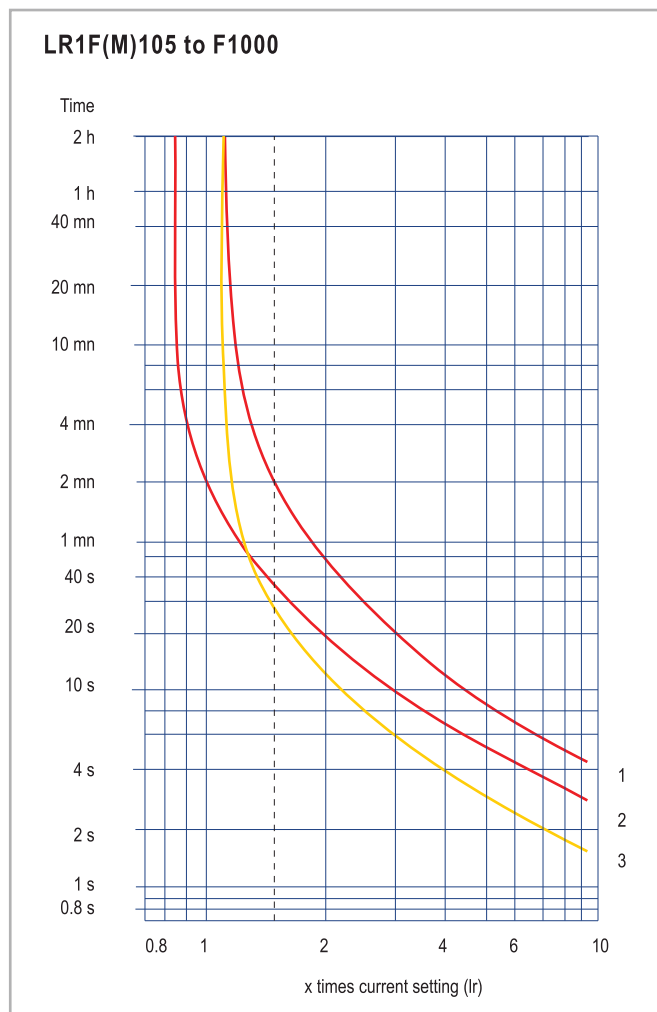
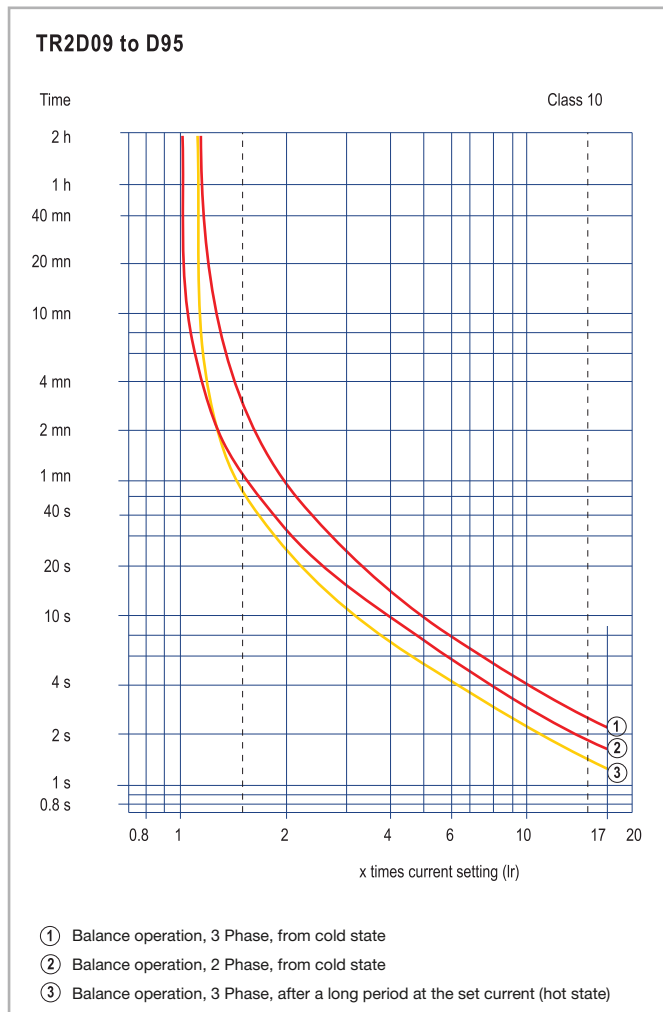

Overload Relay Dimensions

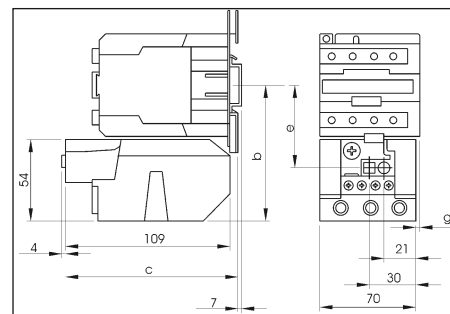
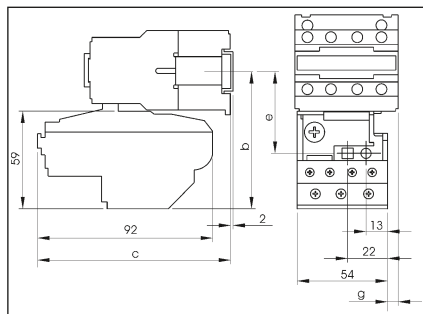
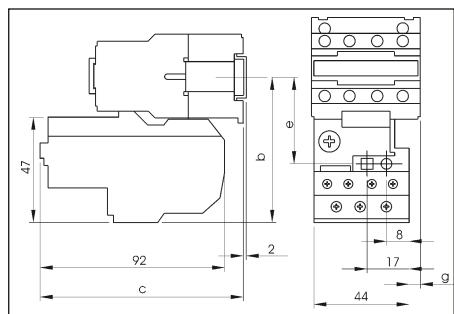

TR2D09301~D25322				
Mounting With	b	c	e	g
TC1D09, D12, D18	81	98	50	0
TP1DC09, DC12				
TC1D25 / TP1DC25	86	108	55	10.7
TC1D32	86	109	55	8.1
TP1D09, D12, D18	81	133	50	0
TP1D25	86	152	55	10.7
TP1D32	86	153	55	8.1

TR2D32353~32355				
Mounting With	b	c	e	g
TC1D25/TP1DC25	97.5	98	60	1.5
TC1D32	97.5	98	60	0.5
TP1D25	97.5	155	60	1.5
TP1D32	97.5	155	60	0.5

TR2D09301~D25322				
Mounting With	b	c	e	g
TC1D40	111	119	72.4	4.5
TC1D50	111	119	72.4	4.5
TC1D65	111	119	72.4	4.5
TC1D80	115.5	123.4	76.9	9.5
TC1D95	115.5	123.4	76.9	9.5
TP1D40	111	176	72.4	4.5
TP1D50	111	176	72.4	4.5
TP1D65	111	176	72.4	4.5
TP1D80	115.5	179.4	76.9	9.5

State of the art Manufacturing Facilities



Haridwar, Noida Ph-I
& Noida Ph-II Plant



C&S Electric Ltd.

Corporate Office: 222, Okhla Industrial Estate, New Delhi - 110 020
Tel. : +91-11-3088 7520 - 29, Fax: +91-11-2684 7154, 2682 9063

International Business Division: Tel. : +91-11-4161 3503, 3088 7520-29, Fax: +91-11-2683 8291, 2684 7342
email : exports@cselectric.co.in

Central Marketing Office: Tel. : +91-11-3088 7520-29, Fax: +91-11-2684 8241, 2684 7342
email : cmo@cselectric.co.in, info@cselectric.co.in

